

Zone 9a Ordering Specification - Euros

FOR OFFICE USE ONLY

Dealer Name:	Purchase Order Number:
Account No.	Frame Number:
	Delivery/Due Date:

Page 1 Of 6 Pages

Ver 1.11

Hi·Lite

Customer Name:	Delivery Address - If different to customer or dealer address:
Customer Address:	
Customer Postcode:	
Customer Telephone:	
Customer Email	

Additional Notes/Comments:

Payment Plan:

Basic Price	€
Options Page _____	€
Options Page _____	€
Options Page _____	€
Options Page _____	€
Options Page _____	€
Options Page _____	€
Options Page _____	€
Grand Total	€
Discount	€
Net Total	€
Deposit	€
Balance	€

Customer Signature _____ Date _____

By signing this order, I understand and agree to the order specification contained on the following pages

NAME IN BLOCK CAPITALS

RGK Official Signature _____

Date _____

POSITION

TOTAL NUMBER OF PAGES TO ORDER 4 5 6 7 8



FOR OFFICE USE ONLY

Dealer Name:

Frame Number:

Customer Name:

Delivery/Due Date:

Frame Material Titanium €3360 Chrome Moly €2495

Front Seat Height

G

Custom Size.....mm

Overall Frame Width

A

Custom Size.....mm

Rear Seat Height

H

Custom Size.....mm

Front Seat Width (Taper Seat)

B1

(N/A with Parallel Taper Front-SF042)

Custom Size.....mm

Overall Frame Length

I

Custom Size.....mm

Footrest Width

B2

Custom Size.....mm

Rear Wheel Gap

C

(Measurement is from outermost point of sideguard to inside tyre)

Backrest Height

J

Custom Size.....mm

15mm 20mm 25mm

With CB1 Titanium Camber Bar minimum 25mm unless fixed

Custom Size.....mm

Castor Pin Width

K

Custom Size.....mm

Camber Angle (with CB1 Titanium Camber Bar Max. 3°)

D

1° 2° 3° 4° 5° 6° 7°

Custom Angle.....degrees

Seat to Footrest- Please only use one method of measurement

L

Custom Size.....mm

Please note that when the requested seat to footrest measurement cannot be achieved a clamp on high level footrest will be fitted at no extra charge

Backrest Angle

E

-10° -7° -5° -3° 0°
 +3° +5° +7° +10°

Custom Angle.....degrees

Footrest Height from Floor- Please only use one method of measurement

20 40 60 80 100 120mm

Custom Size.....

Seat Sling Length

F

Custom Size.....mm

All measurements are Metric (mm) unless otherwise indicated

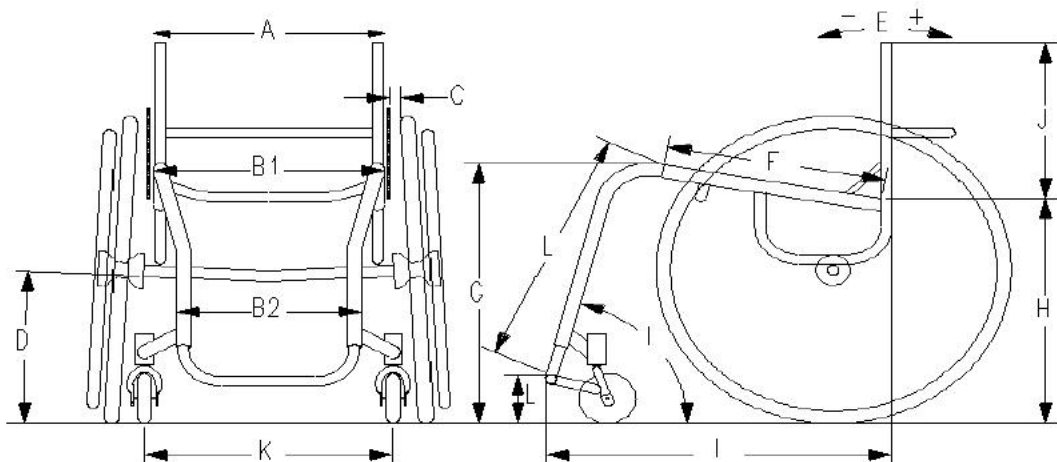

FOR OFFICE USE ONLY

Dealer Name:	Frame Number:
Customer Name:	Delivery/Due Date:

Square Back Frame - SF039
Minimum centre of gravity 40mm

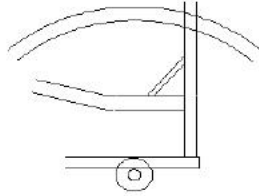

Round Back Frame - SF040

Not available with: SF07 - Transit Wheels

SA12 - Swingaway Armrests

CB2 - Handbike Camber Bar

Minimum Centre of Gravity 85mm

SF01 - Amputee Axle Mounting

AT011 & AT013 - Swingaway Anti Tip

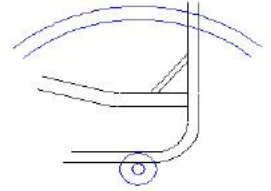

Taper Seat Frame - SF041

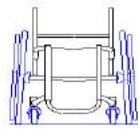

Parallel Taper Front Frame - SF042



Single Tube Frame - SF043

Maximum Seat size in Titanium 460mm x 460mm

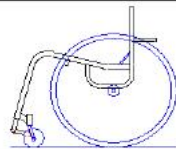

Double Tube Frame - SF044

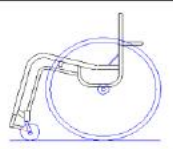

Centre of Gravity - SF048

50 70 100 130 150mm

Custom Position.....mm

Outside of backpost to centre of Camber Bar

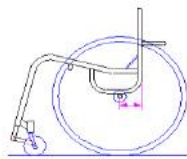

Ergonomic Seat - SF04

Indicate Length

.....mm

€ 72.00

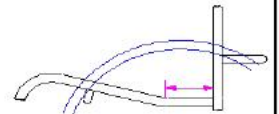

SF06 Fixed Camber Bar

€ 284.00

Custom Position.....mm

Outside of backpost to centre of Camber Bar

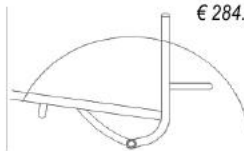

Taper / Flare Back Frame - SF02

€ 72.00

Specify width at top of backrest

.....mm

(Not available with adjustable height backrest)

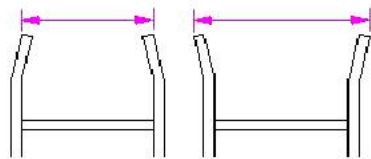

Ergonomic Backrest - SF010

€ 72.00

Vertical Height

.....mm

Rearward Kick for top section

.....mm

(Not available with adjustable height backrest)

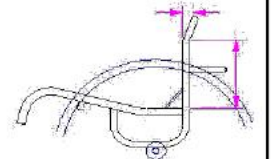

Footrest

- FR023 Tubular Footrest, Std Depth, Std Drop Std
- FR019 Plastic Footrest Cover € 58.00
- FR02 Angle Adjustable Footrest € 95.00
- SF036 Fixed Footrest Integrated into Frame € 76.00
Specify Heightmm
- FR020A Non Standard Footrest Depth NCO
Custom Depthmm
- FR021A Specify Footrest Drop NCO
Custom Dropmm
- FR04A Titanium Footrest, Std on Titanium Frame Std
- FR018 Carbon Fibre Footrest Cover € 113.00

Tubular Footrest - FR023

Angle Adjustable Footrest - FR02

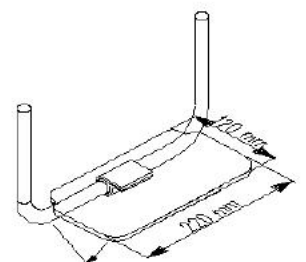
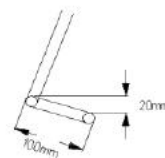
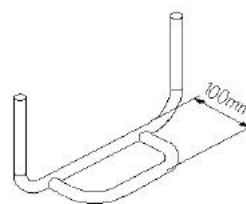

FOR OFFICE USE ONLY

Dealer Name:

Frame Number:

Customer Name:

Delivery/Due Date:

Rear Wheels

- WO19 Radial Spoked Wheel with high flange hub Std
 20" 22" 26"
 WO46 Sun Fusion 16 Spoke Wheel 24" 25" Std
 WO2 12g Heavy Duty Spokes Radial with Hi Flange Hub € 189.00
 24" 25" 26"
 WO5 24" Spider Wheels (Indicate Colour)..... € 261.00
 WO42 Spinergy Flex Rim Daily Wheels 24" 25" € 1,008.00
 Red Yellow Blue White
 Black Pink Orange Green
 WO13B Spinergy Light Extreme Wheels 24" 25" 26" € 630.00
 Red Yellow Blue White
 Black Pink Orange Green
 WO13 Spinergy SPOX Wheels € 450.00
 24" 25" 26"
 Red Yel Blu Whi Blk
 WO4 25" X Core 3 Spoke Carbon Fibre Wheels € 711.00
 WO6 Quad Release Axle Nuts € 133.00
 WO7 Clear Polycarbonate Spokeguards € 104.00
 WO18 Supply minus wheels - Deduct from basic -€ 180.00

Please indicate wheel and tyre size and style for manufacturing purposes

Hand Rims

- HR011 Aluminium Silver Anodised Std
 Wide Set Narrow Set
 HR01 Plastic Coated 20,22,24,25,26" (Not Spider or X Core) € 133.00
 HR02 Rubber Coated 24", 25", 26" (Not Spider or X Core) € 209.00
 HR03 Stainless Steel 24", 25", 26" (Not Spider or X Core) € 113.00
 HR04 Titanium 24", 25", 26" (Not Spider or X Core) € 284.00
 HR06 Dual Grip 24", 25", 26" (Not Spider or X Core) € 133.00
 HR013 Tetra Grip Push Rim (24" & 25" only) € 243.00
 HR014 Para Grip Push Rim (24" & 25" only) € 243.00

Castor Wheels

- C08 72mm Krypto Castor Wheel NCO
 C09 100mm Krypto Castor Wheel Std
 C010 100mm Soft Roll Castor Wheel NCO
 C011 125mm Soft Roll Castor Wheel NCO
 C017 150mm Soft Roll Castor Wheel NCO
 C06 3 Spoke Aluminium Centre Frog Legs Castor Wheel 100mm € 108.00
 wide narrow
 C012 3 Spoke Aluminium Centre Frog Legs Castor Wheel 125mm € 108.00
 wide narrow
 C01 Pneumatic Castor 125mm Aluminium Centre € 122.00
 C07 Pneumatic Castor 150mm € 122.00
 C03 100mm Flashing Castor Wheel € 47.00

Tyres

- WO9 Kenda High Pressure (22" Grey only) Std
 Grey Blue Red Orange
 WO40 Schwalbe Marathon Plus Tyres (24", 25", 26" only) € 58.00
 WO43 Kenda Treaded High Perf. (K184) 24"x 1 25" x 1 € 20.00
 WO10 Solid Tyre 24"x 1 25" x 1 € 95.00
 WO22 Mountain Bike Tyres € 20.00
 Semi Slick 25"(K193) Knobbly 25" (K885) Knobbly 24" (K885)
 WO23 24" X 1 3/8" Outdoor Tyre (K161) NCO
 Indicate Valve Style Presta (Not 20" or 22") Schraeder

Castor Forks

- C02 Frog Leg Suspension Forks Silver Black € 398.00
 C021 Single Side Castor Forks Silver Black € 113.00
 C022 Single Side Castor Forks Silver Black € 191.00
 (Only available with CO41)
 C041 Closed Castor Pots (Only available with CO22) € 171.00
 Please Indicate Style:

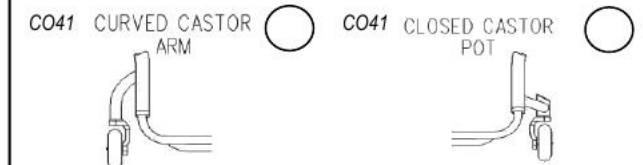

Anti Tippers - Indicate colour.....(only colours with 1 as prefix)

- AT02 Basketball V Style with 72mm Wheel € 207.00
 AT011 Swing Away Anti-Tip One Side only (BLK only) € 122.00
 Left Right
 AT013 Swing Away Anti-Tip both sides (BLK only) € 256.00

(Swing Away Anti-Tip - N/A with Swing away armrests - SA6)

Camber Bar

- CB1 Titanium Camber Bar € 180.00
 (NCO with Fixed Camber Bar on Titanium Frame -Maximum Camber 3° unless fixed
 (Only AT011 & AT013 Swing Away Anti Tip available with Titanium Camber Bar unless fixed)
 CB9 Frog Legs Suspension Camber Bar € 576.00
 CB2 Quick Release Hand Bike Camber Bar € 252.00
 CB2A Fixed Handbike Wheelbase Extensions € 252.00
 (Not available with round backed frame SF040
 5° Camber 0° Camber Custom.....

FOR OFFICE USE ONLY

Dealer Name:

Frame Number:

Customer Name:

Delivery/Due Date:

Backrest

- BR012 Fixed Backrest Std
 - BR011 Folding Backrest with Snap Lock & Lock when Folded € 284.00
 - BR014 Flip Down Push Handles € 216.00
 - BR02 Adjustable Height Backrest € 113.00
 Indicate Lowest Heightmm
 - BR03 Screw in Push Handles € 133.00
 - BR04 Stroller Push Handles € 248.00
- Height from Floor 810mm 910mm 1000mm
- Custommm

Frame Colours

- F09 Powder Coated Standard -Specify Code..... Std
 - F02 Flam Frame Finish Number Prefix 8/4 Code..... € 76.00
 - F04 Polished Frame Finish (Titanium) € 380.00
 - F05 Sparkle Frame Finish Number Prefix 2 Code..... € 76.00
 - F06 Bead Blast Frame Finish (Titanium) € 85.00
 - F07 Pearlescent Frame Finish Number Prefix 9 Code..... € 180.00
 - F08 Leather Frame Finish Number Prefix 3 Code..... € 76.00
 - F010 Fantasy Frame Finish Number Prefix 5 Code..... € 95.00
 - F04B Polished Components € 146.00
- Footrest-Specify Code (BLK Standard).....
- Camber Bar-Specify Code (BLK Standard).....
- Castor Forks-Specify Code (BLK Standard).....
- H Frame (Folding Back only)(As Frame- Standard).....
- Pivot Plates (Folding Back only) (BLK-Standard).....

Sideguards

- SA1 Fabric Sideguards € 76.00
- SA24 Non Removable Aluminium Sideguards* € 151.00
- SA25 Non Removable Aluminium Sideguards with Fender** € 180.00
- SA26 Non Removable Carbon Fibre Sideguards* € 340.00
- SA27 Non Removable Carbon Fibre Sideguards with Fender** € 468.00
- SA28 Welded Titanium Sideguards* € 322.00
(Only with Titanium Frame, Fixed Backrest)
- SA29 Welded Chrome Moly Sideguards* € 284.00
(Only with Chrome Moly Frame, Fixed Backrest)
- SA4 Flip Back Plastic Sideguards - BLK only* € 180.00
- SA5 Lift Out Plastic Sideguards - BLK only* € 227.00
- SA8 Lift Out Plastic Sideguards with Fender - BLK only € 311.00
- SA14 Lift Out Aluminium Sideguards* € 365.00
- SA30 Lift Out Aluminium Sideguards with Fender** € 311.00

***Specify size**

- 25mm Below Tyre Level with Tyre 25mm Above Tyre

Custom size

Height..... Length

**Specify Fender Size -----Standard 10mm above tyre

Fender Width

- To centre of tyre To outside of tyre

Sideguard Colour - Aluminium only

Armrests

- SA6 Swingaway Tubular € 218.00
 (N/A with AT011 & AT013 Swing Away Anti Tip)
 Specify Height from seat
 (Mid point of seat depth to top of arm rest).....
- SA7 Height Adjustable, with integral Sideguard € 378.00
 Specify Length from inside of Backpost.....

Other Options

- SF01 Amputee Axle Mounting € 104.00
- SF07 Air Plane (Transit) Wheels (Pair) € 265.00
- SF027 Calf Strap Mounting Loops € 47.00

Brakes

- BO1 Push to Lock Brakes NCO
- BO2 Under Seat Scissor Brakes Std
- BO3 Brake Lever Extensions(Push to Lock Only) € 133.00
- BO4A Push to Lock Brake (Flip Away) € 445.00
- BO8B Short Throw Scissor Brake € 108.00
- BO10 Omit Brakes -€36.00

FOR OFFICE USE ONLY

Dealer Name:

Frame Number:

Customer Name:

Delivery/Due Date:

Accessories

- 001 Crutch Holder € 86.00
 Left Right
(N/A with Swingaway Anti Tip or Swingaway Arm Rests)
- 0012 Crutch Holder Both Sides € 175.00
(N/A with Swingaway Anti Tip or Swingaway Arm Rests)
- 002 Frame Caddies (Pair) € 121.00
- 004 Seat Pouch Velcro Attach € 32.00
 Black Red Blue
- 007 Black Box Underseat Storage € 76.00
 Large Small
- 005 Back Pack € 76.00
- 006 Lap Strap Buckle Fasten 50mm € 23.00
- 008 Under Seat Net € 45.00

Conversion Chart for Wheels from Imperial to Metric

<u>Wheel Size</u>	<u>Wheel Size</u>
20"	451
22"	501
24"	540
25"	559
26"	590

Upholstery

- U024 Backrest Velcro Adjustable Blk Red Blu Std
- U025 Seat Velcro Adjustable Blk Red Blu Std
- U07 Cushion € 70.00
 50mm Soft Black
 75mm Med Red
 100mm Hard Blue
- U08 Frame Protectors € 34.00
 Black Red Blue
- U01 Strap Adjustable Backrest € 47.00
- U02 Leather Cushion Cover - Specify Colour € 88.00
- U04 Leather Backrest Upholstery - Specify Colour € 171.00
- U013 Strap Adjustable Seat € 47.00
- U034 Leather Corners on Backrest Upholstery € 54.00
Specify Colour
- U05 Leather Wings - Specify Colour € 122.00
- U028 Air Lite Backrest Upholstery € 95.00
- U028B Air Lite Centre Pad € 67.00
- U029 Air Lite Cushion Cover € 47.00
- U026 Omit Upholstery (Deduct) -€ 54.00