

# Zone 9a Ordering Specification - Euros

**FOR OFFICE USE ONLY**

Dealer Name:	Purchase Order Number:
Account No.	Frame Number:
	Delivery/Due Date:

Page 1 Of 6 Pages Ver 1.11

# Octane

Customer Name:	Delivery Address - If different to customer or dealer address:
Customer Address:	
Customer Postcode:	
Customer Telephone:	
Customer Email	

**Additional Notes/Comments:**

**Payment Plan:**

Customer Signature \_\_\_\_\_ Date \_\_\_\_\_

By signing this order, I understand and agree to the order specification contained on the following pages

NAME IN BLOCK CAPITALS

RGK Official Signature \_\_\_\_\_

Date \_\_\_\_\_

POSITION

Basic Price	€
Options Page _____	€
Options Page _____	€
Options Page _____	€
Options Page _____	€
Options Page _____	€
Options Page _____	€
Options Page _____	€
Grand Total	€
Discount	€
Net Total	€
Deposit	€
Balance	€



**FOR OFFICE USE ONLY**

Dealer Name:

Frame Number:

Customer Name:

Delivery/Due Date:

**Frame Material**  Titanium €4265

**Overall Frame Width** **A**

Custom Size.....mm

**Front Seat Width (Taper Seat)** **B1**

(N/A with Parallel Taper Front-SF042)

Custom Size.....mm

**Footrest Width** **B2**

Custom Size.....mm

**Rear Wheel Gap** **C**

(Measurement is from outermost point of sideguard to inside tyre)

15mm  20mm  25mm

Custom Size.....mm

**Camber Angle** **D**

1°  2°  3°  4°  5°  6°  7°

Custom Angle.....degrees

**Backrest Angle** **E**

-10°  -7°  -5°  -3°  0°  
 +3°  +5°  +7°  +10°

Custom Angle.....degrees

**Seat Sling Length** **F**

Custom Size.....mm

**Front Seat Height** **G**

Custom Size.....mm

**Rear Seat Height** **H**

Custom Size.....mm

**Overall Frame Length** **I**

Custom Size.....mm

**Backrest Height** **J**

Custom Size.....mm

**Castor Pin Width** **K**

Custom Size.....mm

**Seat to Footrest- Please only use one method of measurement** **L**

Custom Size.....mm

*Please note that when the requested seat to footrest measurement cannot be achieved a clamp on high level footrest will be fitted at no extra charge*

**Footrest Height from Floor- Please only use one method of measurement**

20  40  60  80  100  120mm

Custom Size.....mm

All measurements are Metric (mm) unless otherwise indicated

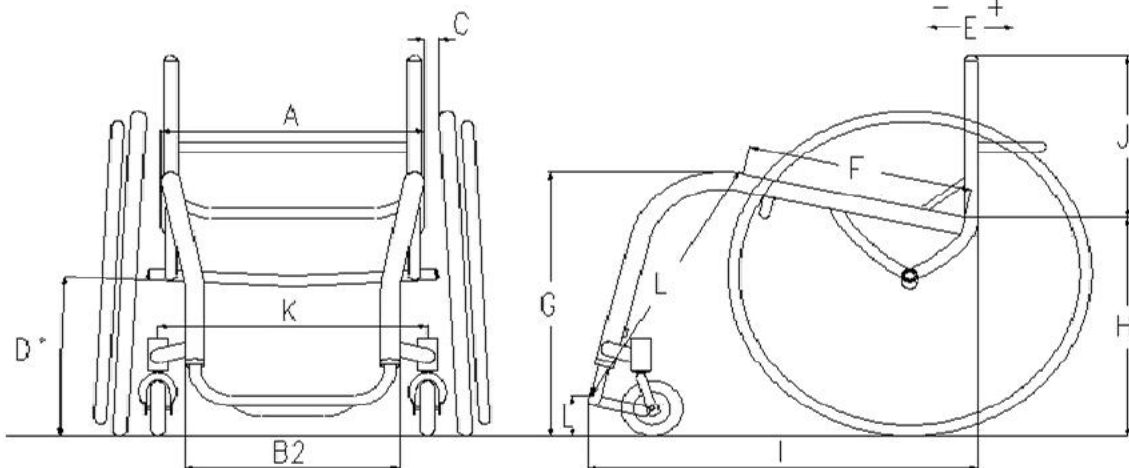

Dealer Name:

Frame Number:

Customer Name:

Delivery/Due Date:

Taper Seat Frame - SF041

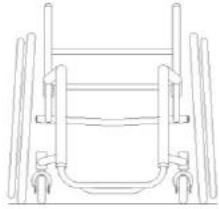

Parallel Taper Front Frame - SF042



Single Tube Frame - SF043  
Max Seat Width 460mm x 460mm

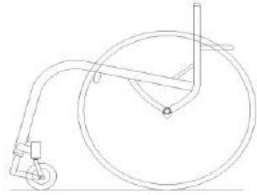

Ergonomic Seat - SF04

€ 72.00

Indicate Length

.....mm

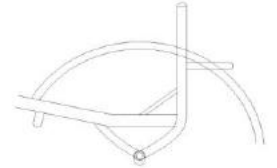

Fixed Camber Bar - SF06C - Standard

Indicate Centre of Gravity

50  70  100  130  150mm

Outside of backpost to centre of Camber Bar

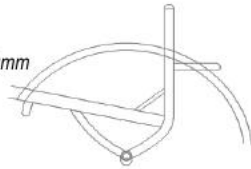

Custom Position.....mm

Ergonomic Backrest - SF010

€ 72.00

Vertical Height

.....mm

Rearward Kick for top section

.....mm

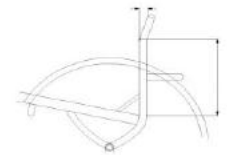

Taper / Flare Back Frame - SF02

€ 72.00

Specify width at top of backrest

.....mm

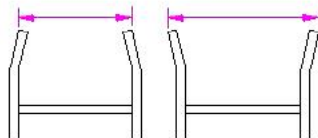

(Not available with adjustable height backrest)

**Footrest**

- FR04A  Titanium Tubular Footrest, Std Depth, Std Drop Std
- FR019  Plastic Footrest Cover € 58.00
- FR02  Angle Adjustable Footrest € 95.00
- SF036  Fixed Footrest Integrated into Frame € 76.00  
Specify Height .....mm
- FR020A  Non Standard Footrest Depth NCO  
Custom Depth .....mm
- FR021A  Specify Footrest Drop NCO  
Custom Drop .....mm
- FR018  Carbon Fibre Footrest Cover € 113.00

**Tubular Footrest - FR023**

**Angle Adjustable Footrest - FR02**

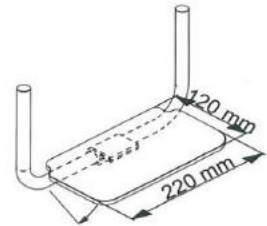
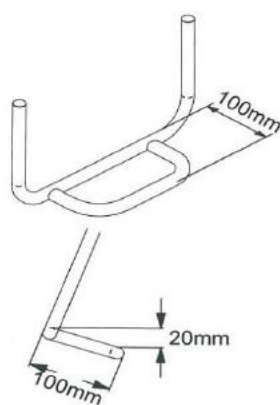

**FOR OFFICE USE ONLY**

Dealer Name:

Frame Number:

Customer Name:

Delivery/Due Date:

**Rear Wheels**

- WO19  Radial Spoked Wheel with high flange hub Std  
 20"  22"  26"
- WO46  Sun Fusion 16 Spoke Wheel  24"  25" Std
- WO2  12g Heavy Duty Spokes Radial with Hi Flange Hub € 189.00  
 24"  25"  26"
- WO5  24" Spider Wheels (Indicate Colour)..... € 261.00
- WO42  Spinergy Flex Rim Daily Wheels  24"  25" € 1,008.00  
 Red  Yellow  Blue  White  
 Black  Pink  Orange  Green
- WO13B  Spinergy Light Extreme Wheels  24"  25"  26" € 630.00  
 Red  Yellow  Blue  White  
 Black  Pink  Orange  Green
- WO13  Spinergy SPOX Wheels € 450.00  
 24"  25"  26"  
 Red  Yel  Blu  Whi  Blk
- WO4  25" X Core 3 Spoke Carbon Fibre Wheels € 711.00
- WO6  Quad Release Axle Nuts € 133.00
- WO7  Clear Polycarbonate Spokeguards € 104.00
- WO18  Supply minus wheels - Deduct from basic -€ 180.00

Please indicate wheel and tyre size and style for manufacturing purposes .....

**Hand Rims**

- HR011  Aluminium Silver Anodised Std  
 Wide Set  Narrow Set
- HR01  Plastic Coated 20,22,24,25,26" (Not Spider or X Core) € 133.00
- HR02  Rubber Coated 24", 25", 26" (Not Spider or X Core) € 209.00
- HR03  Stainless Steel 24", 25", 26" (Not Spider or X Core) € 113.00
- HR04  Titanium 24", 25", 26" (Not Spider or X Core) € 284.00
- HR06  Dual Grip 24", 25", 26" (Not Spider or X Core) € 133.00
- HR013  Tetra Grip Push Rim (24" & 25" only) € 243.00
- HR014  Para Grip Push Rim (24" & 25" only) € 243.00

**Castor Wheels**

- C08  72mm Krypto Castor Wheel NCO
- C09  100mm Krypto Castor Wheel Std
- C010  100mm Soft Roll Castor Wheel NCO
- C011  125mm Soft Roll Castor Wheel NCO
- C017  150mm Soft Roll Castor Wheel NCO
- C06  3 Spoke Aluminium Centre Frog Legs Castor Wheel 100mm € 108.00  
 wide  narrow
- C012  3 Spoke Aluminium Centre Frog Legs Castor Wheel 125mm € 108.00  
 wide  narrow
- C01  Pneumatic Castor 125mm Aluminium Centre € 122.00
- C07  Pneumatic Castor 150mm € 122.00
- C03  100mm Flashing Castor Wheel € 47.00

**Tyres**

- WO9  Kenda High Pressure (22" Grey only) Std  
 Gry  Blu  Red  Orange
- WO40  Schwalbe Marathon Plus Tyres (24", 25", 26" only) € 58.00
- WO43  Kenda Treaded High Perf. (K184)  24"  25" € 20.00
- WO10  Solid Tyre  24"x 1  25" x 1 € 95.00
- WO22  Mountain Bike Tyres € 20.00  
 Semi Slick 25"(K193)  Knobbly 25" (K885)  Knobbly 24" (K885)
- WO23  24" X 1 3/8" Outdoor Tyre (K161) NCO

Indicate Valve Style  Presta (Not 20" or 22")  Schraeder

**Castor Forks**

- C02  Frog Leg Suspension Forks  Silver  Black € 398.00
- C021  Single Side Castor Forks  Silver  Black € 113.00
- C022  Single Side Castor Forks  Silver  Black € 191.00
- C041  Closed Castor Pots (Only available with C022) € 171.00

Please Indicate Style:

C041 CURVED CASTOR ARM

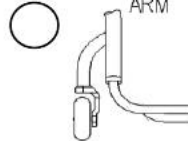

C041 CLOSED CASTOR POT



**FOR OFFICE USE ONLY**

Dealer Name:

Frame Number:

Customer Name:

Delivery/Due Date:

**Backrest**

- BR012  Fixed Backrest Std
- BR02  Adjustable Height Backrest € 113.00  
 Indicate Lowest Height .....mm
- BR014  Flip Down Push Handles € 216.00
- BR03  Screw in Push Handles € 133.00
- BR04  Stroller Push Handles € 284.00  
 Height from Floor  810mm  910mm  1000mm  
 Custom .....mm

**Frame Colours**

- F09  Powder Coated Standard -Specify Code..... Std
- F02  Flam Frame Finish Number Prefix 8/4 Code..... € 76.00
- F04  Polished Frame Finish (Titanium) € 380.00
- F05  Sparkle Frame Finish Number Prefix 2 Code..... € 76.00
- F06  Bead Blast Frame Finish (Titanium) € 85.00
- F07  Pearlescent Frame Finish Number Prefix 9 Code..... € 180.00
- F08  Leather Frame Finish Number Prefix 3 Code..... € 76.00
- F010  Fantasy Frame Finish Number Prefix 5 Code..... € 95.00
- F04B  Polished Components € 146.00
- Footrest-Specify Code (BLK Standard).....
- Camber Bar-Specify Code (BLK Standard).....
- Castor Forks-Specify Code (BLK Standard).....
- H Frame (Folding Back only)(As Frame- Standard).....
- Pivot Plates (Folding Back only) (BLK-Standard).....

**Sideguards**

- SA1  Fabric Sideguards € 76.00
- SA24  Non Removable Aluminium Sideguards\* € 151.00
- SA25  Non Removable Aluminium Sideguards with Fender\*\* € 180.00
- SA26  Non Removable Carbon Fibre Sideguards\* € 340.00
- SA27  Non Removable Carbon Fibre Sideguards with Fender\*\* € 468.00
- SA28E  Welded Titanium Sideguards € 536.00
- SA4  Flip Back Plastic Sideguards - BLK only\* € 180.00

**\*Specify size**

- 25mm Below Tyre  Level with Tyre  25mm Above Tyre

**Custom size**

Height..... Length .....

\*\*Specify Fender Size -----Standard 10mm above tyre

Fender Width

- To centre of tyre  To outside of tyre

Sideguard Colour - Aluminium only

.....

**Brakes**

- BO1  Push to Lock Brakes NCO
- BO2  Under Seat Scissor Brakes Std
- BO3  Brake Lever Extensions(Push to Lock Only) € 133.00
- BO4A  Push to Lock Brake (Flip Away) € 445.00
- BO8B  Short Throw Scissor Brake € 108.00
- BO10  Omit Brakes -€36.00

**Other Options**

- SF027  Calf Strap Mounting Loops € 47.00

**FOR OFFICE USE ONLY**

Dealer Name:

Frame Number:

Customer Name:

Delivery/Due Date:

**Accessories**

- 002  Frame Caddies (Pair) € 121.00
- 004  Seat Pouch Velcro Attach € 32.00
  - Black       Red       Blue
- 007  Black Box Underseat Storage € 76.00
  - Large       Small
- 005  Back Pack € 76.00
- 006  Lap Strap Buckle Fasten 50mm € 23.00
- 008  Under Seat Net € 45.00

**Conversion Chart for Wheels from Imperial to Metric**

<u>Wheel Size</u>	<u>Tyre Size</u>
20"	451
22"	501
24"	540
25"	559
26"	590

**Upholstery**

- U024  Backrest Velcro Adjustable  Blk  Red  Blu Std
- U025  Seat Velcro Adjustable  Blk  Red  Blu Std
- U07  Cushion € 70.00
  - 50mm       Soft       Blk
  - 75mm       Med       Red
  - 100mm       Hard       Blu
- U08  Frame Protectors € 34.00
  - Black       Red       Blue
- U01  Strap Adjustable Backrest € 47.00
- U02  Leather Cushion Cover - Specify Colour ..... € 88.00
- U04  Leather Backrest Upholstery - Specify Colour ..... € 171.00
- U013  Strap Adjustable Seat € 47.00
- U034  Leather Corners on Backrest Upholstery € 54.00
  - Specify Colour .....
- U05  Leather Wings - Specify Colour ..... € 122.00
- U028  Air Lite Backrest Upholstery € 95.00
- U028B  Air Lite Centre Pad € 67.00
- U029  Air Lite Cushion Cover € 47.00
- U026  Omit Upholstery (Deduct) -€ 54.00